

LED Flush Mount

FM43121
INSTALLATION SHEET

START FROM HERE

- Make sure power is completely off at the fuse box.
- Have your fixture installed by a qualified licensed electrician
- Prepare everything in a clear area.
- Wear gloves at all times during this installation.
- Read instructions carefully before you start assembly.
- Keep this instruction sheet for future reference.

Technical Support: 1-855-855-8926

Please Note:

- All Kuzco LED fixture comes with pre-wired LED module(s).
- Unless instructed to do so, please do not touch any part of the LED module(s) as any unnecessary contact with the module could cause permanent damage.
- For dimming, an ELV (Electronic Low Voltage) type of dimmer is required.

- 1.** Remove fixture from its original package
- 2.** Separate crossbar (1c) from backplate (2a) by removing crossbar screws (1d)
- 3.** Attach crossbar (1c) to electrical junction box (1a) using screws provided (1e) in hardware package
- 4.** Make proper electrical connections (black to hot "L", white to neutral "N", ground to "GND") with wire nuts (1b) provided in hardware package
- 5.** Attach backplate (2a) to crossbar (1c) with crossbar screws (1d). Secure backplate (2a) to ceiling with additional screws (1g) and anchors (1f)
- 6.** Twist shade (3a) onto backplate (2a) to secure

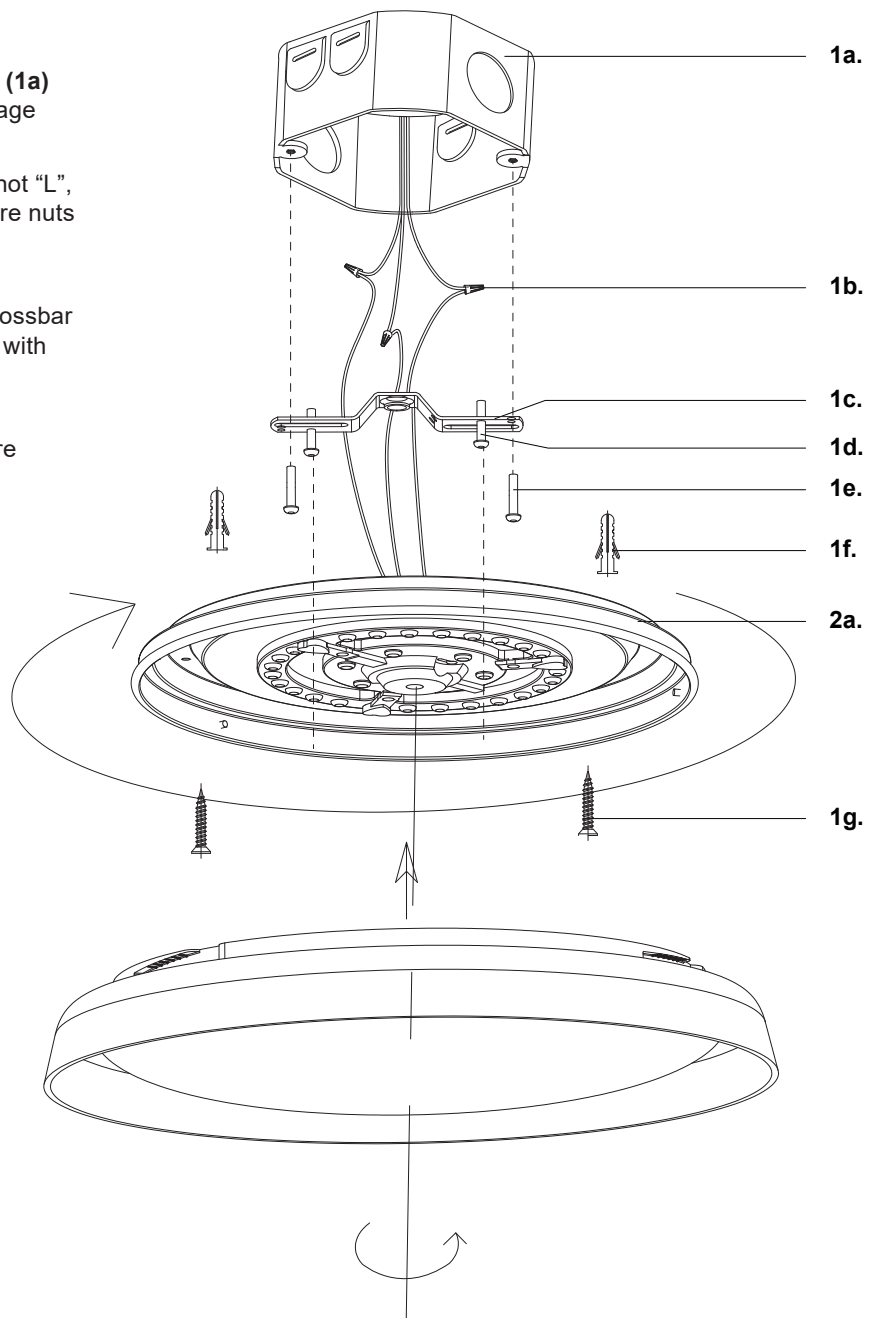

KUZCO

19054 28th Avenue Surrey, BC Canada V3Z 6M3
T: 604 538 7162 TF: 1-855 85 KUZCO F: 604 538 7196
W: kuzcolighting.com
20200323